

Variant 01

① FABRICATION

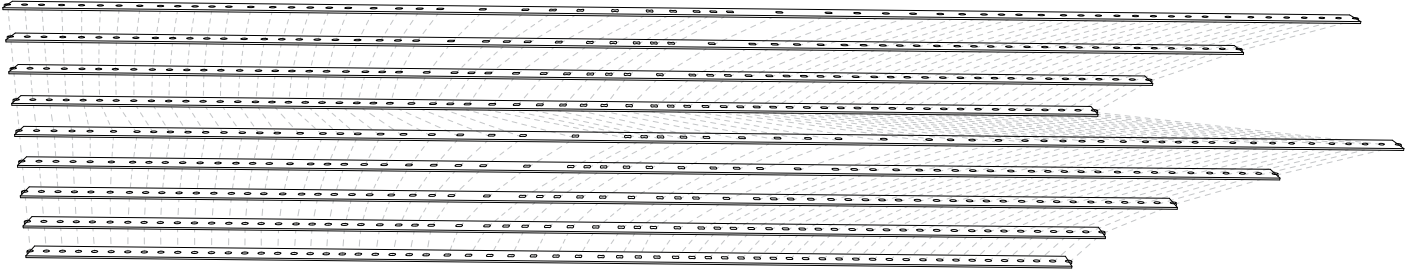

② ASSEMBLY

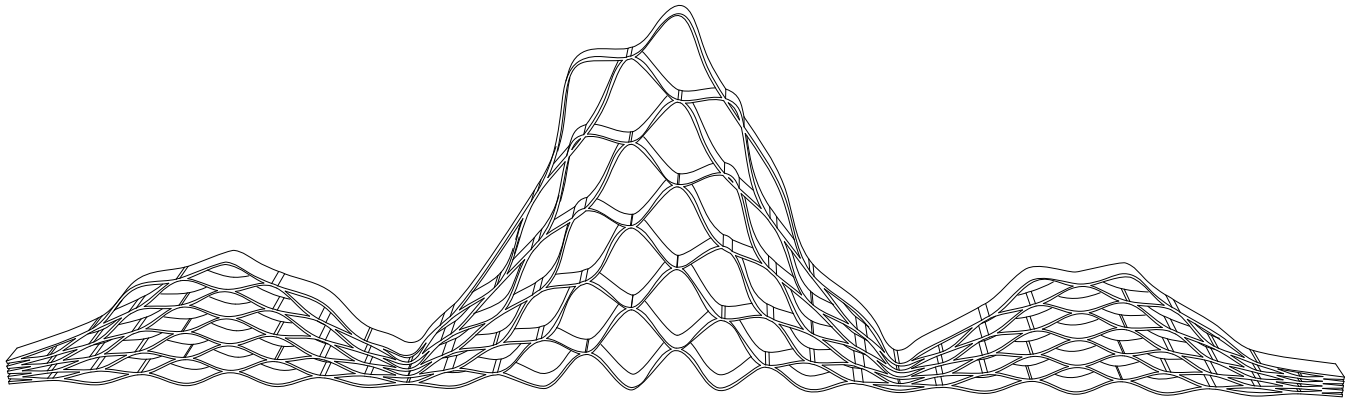

③ FORM - FINDING

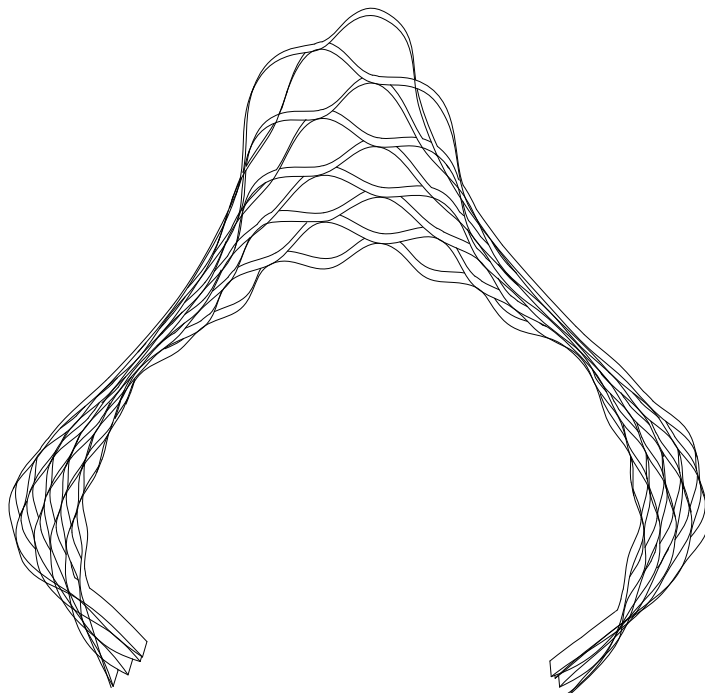

Variant 02

① FABRICATION

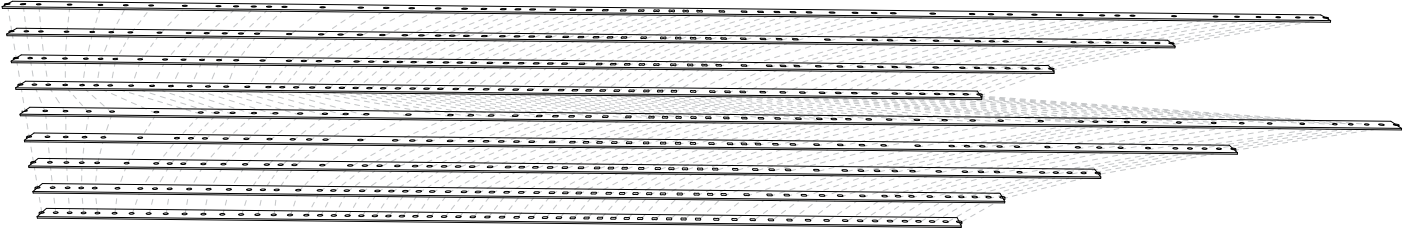

② ASSEMBLY

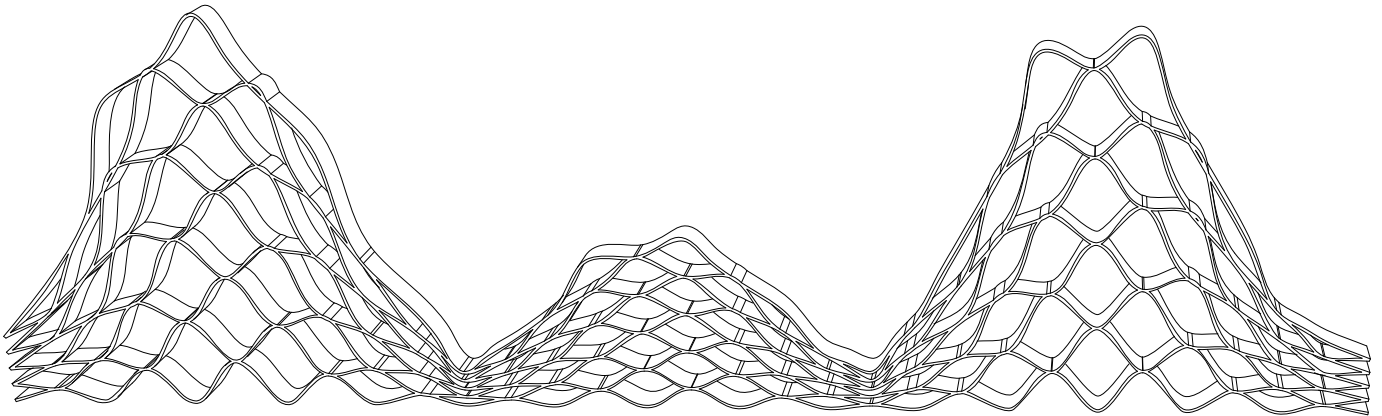

③ FORM - FINDING

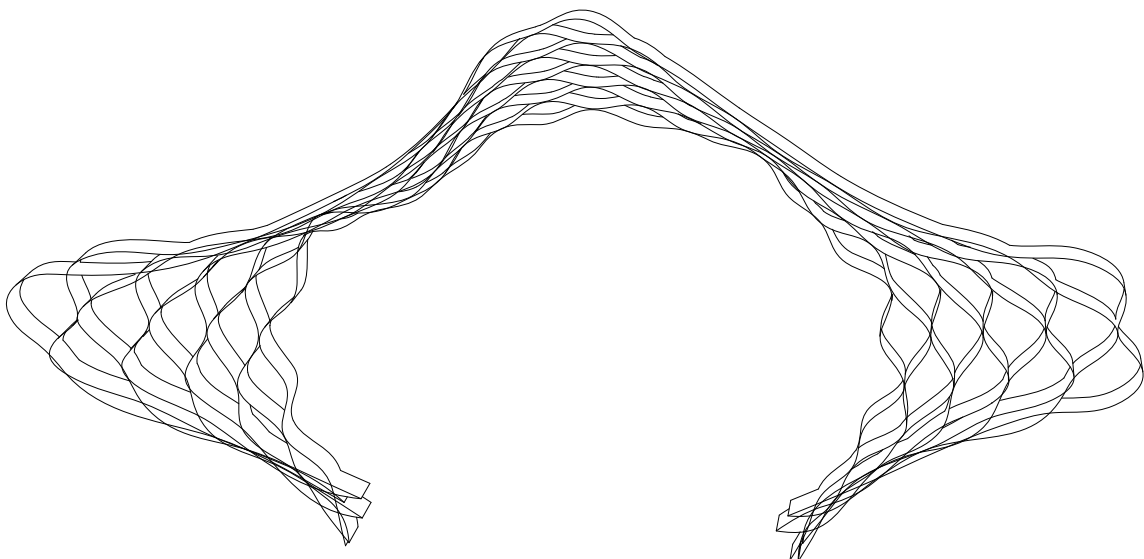

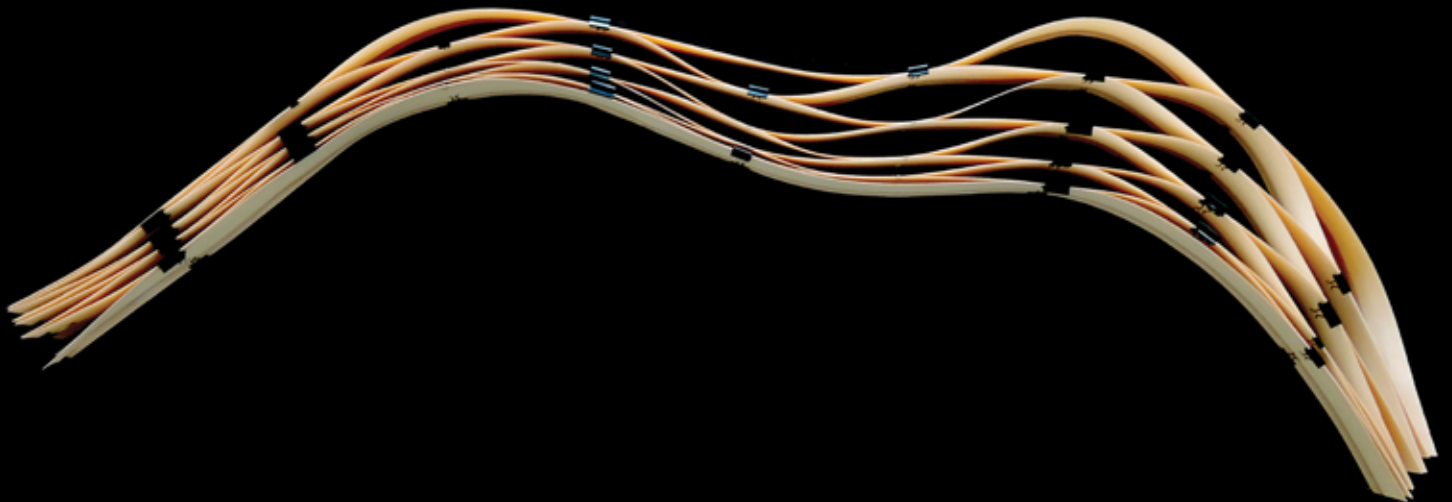
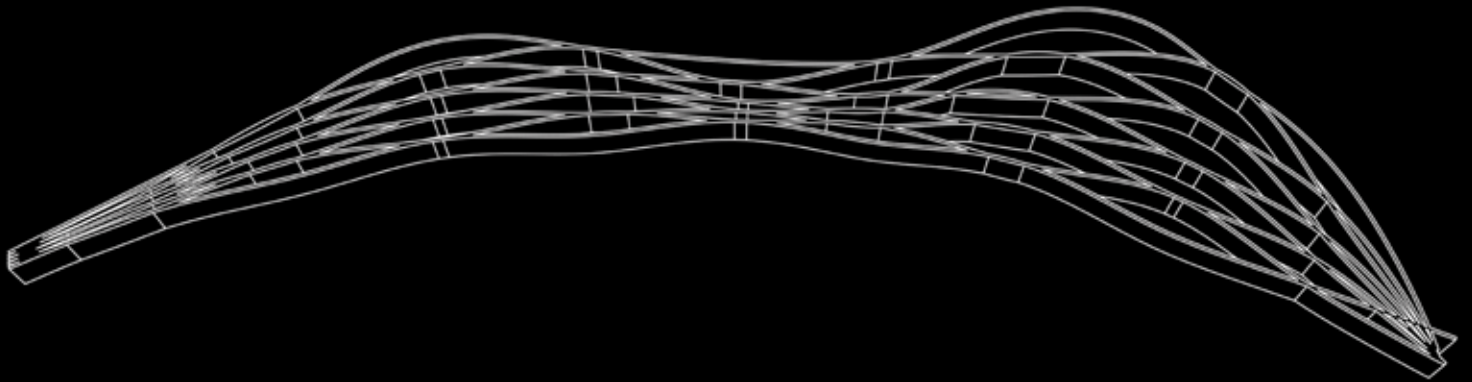
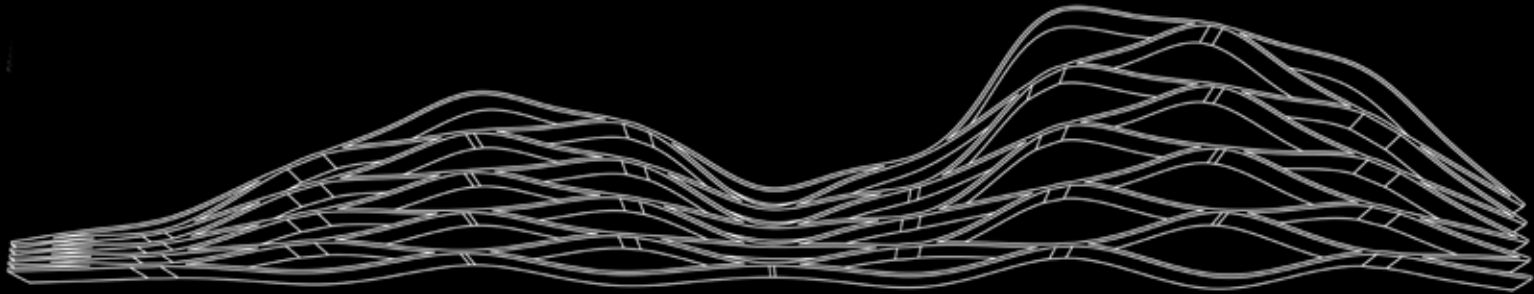

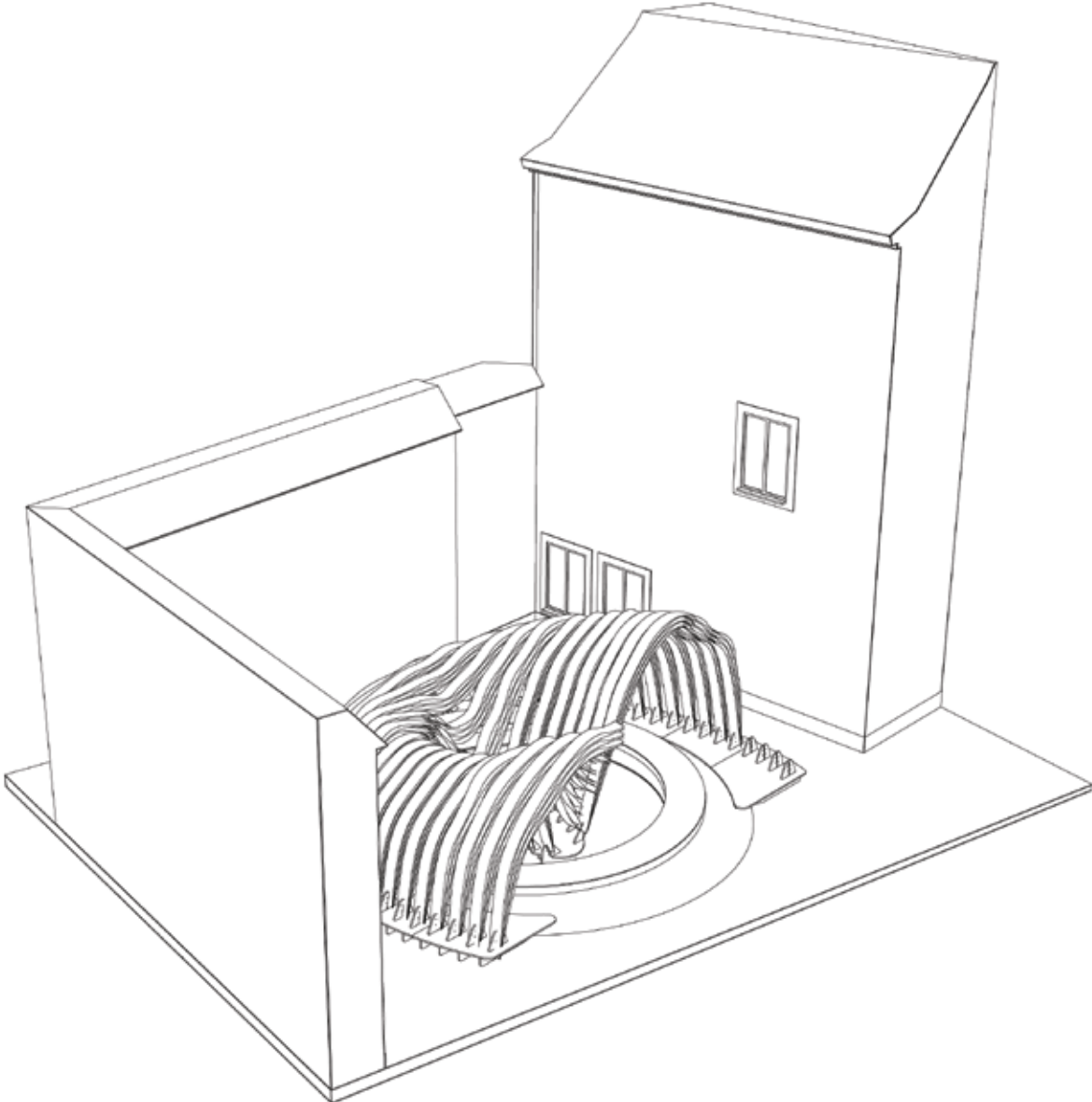

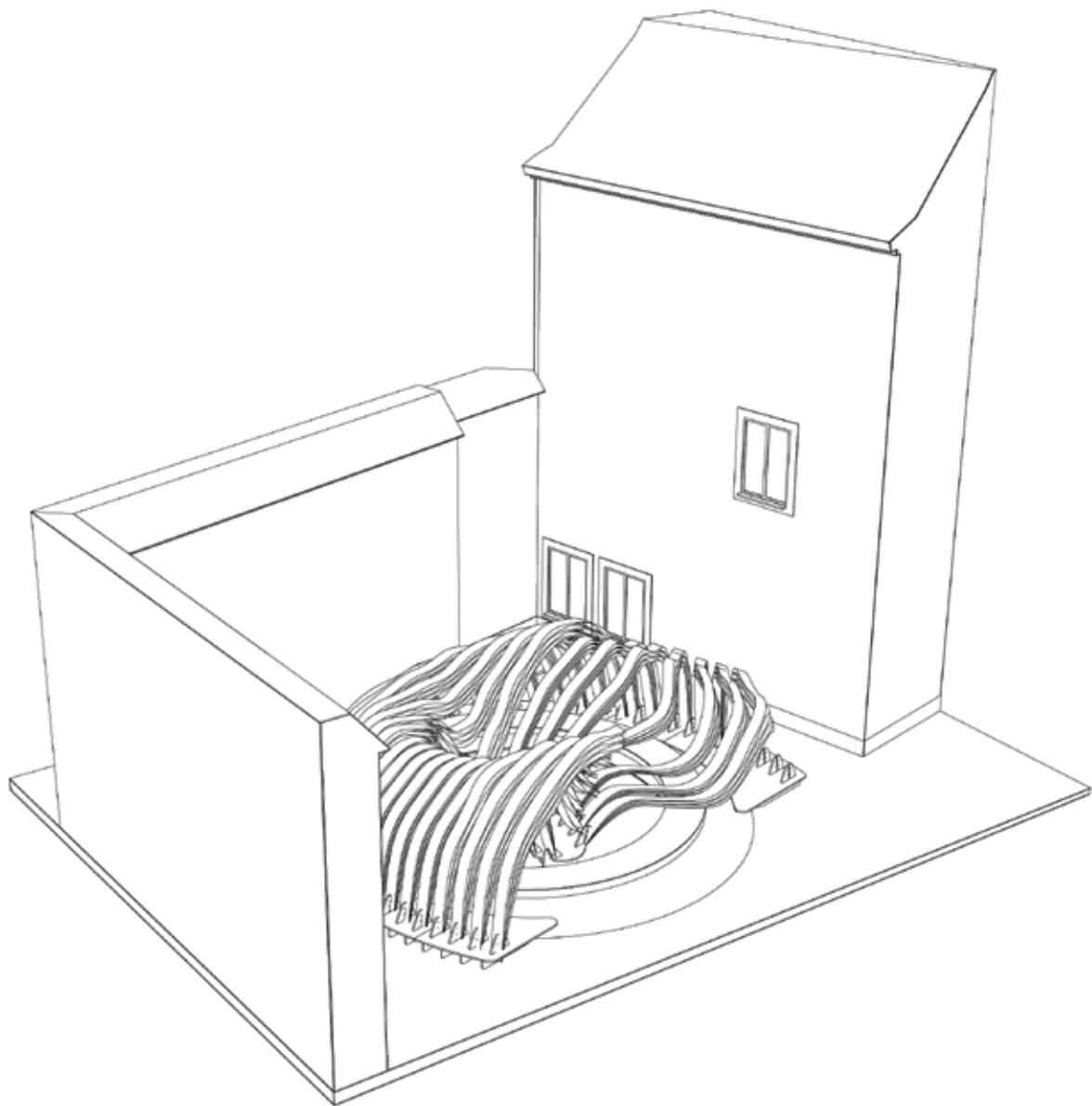

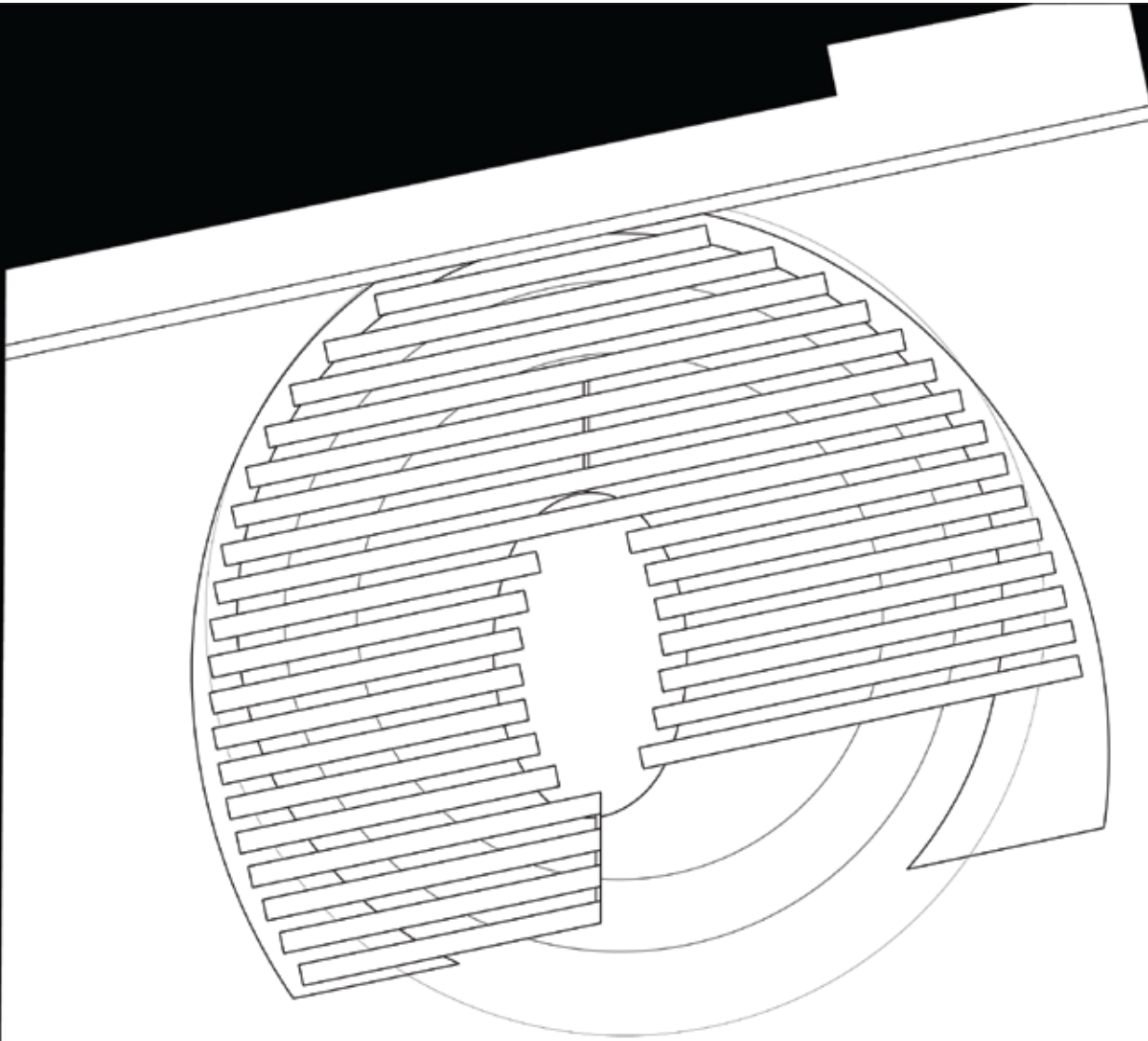

Programmable Bending - A Research Pavilion, architectural design by Shota Tsikoliya

